



TAPPO PROFILO - CAP PROFILE 18 x 32

CODICE CODE	MATERIALE MATERIAL
084.201.003	Poliammide nero - <i>Black polyamide</i>



TAPPO PROFILO - CAP PROFILE 18 x 45

CODICE CODE	MATERIALE MATERIAL
084.201.004	Poliammide nero - <i>Black polyamide</i>



TAPPO PROFILO - CAP PROFILE 18 x 45

CODICE CODE	MATERIALE MATERIAL
084.201.006	Poliammide nero - <i>Black polyamide</i>



TAPPO PROFILO - CAP PROFILE 32 x 32

CODICE CODE	MATERIALE MATERIAL
084.201.009	Poliammide nero - <i>Black polyamide</i>



TAPPO PROFILO TONDO - CAP ROUND PROFILE 32 x 32

CODICE CODE	MATERIALE MATERIAL
084.201.010	Poliammide nero - <i>Black polyamide</i>



TAPPO PROFILO 4 CAVE - 4 CHANNELS CAP PROFILE 32 x 32

CODICE CODE	MATERIALE MATERIAL
084.201.029	Poliammide nero - <i>Black polyamide</i>



TAPPO PROFILO - CAP PROFILE 32 x 45

CODICE CODE	MATERIALE MATERIAL
084.201.011	Poliammide nero - <i>Black polyamide</i>



TAPPO PROFILO - CAP PROFILE 45 x 45

CODICE CODE	MATERIALE MATERIAL
084.201.012	Poliammide nero - <i>Black polyamide</i>



TAPPO PROFILO ANGOLARE - CAP ANGULAR PROFILE 45 x 45

CODICE CODE	MATERIALE MATERIAL
084.201.013	Poliammide nero - <i>Black polyamide</i>



TAPPO PROFILO - CAP PROFILE 18 x 90

CODICE CODE	MATERIALE MATERIAL
084.201.014	Poliammide nero - <i>Black polyamide</i>



TAPPO PROFILO - CAP PROFILE 18 x 180

CODICE CODE	MATERIALE MATERIAL
084.201.015	Poliammide nero - <i>Black polyamide</i>



TAPPO PROFILO - CAP PROFILE 45 x 120

CODICE CODE	MATERIALE MATERIAL
084.201.016	Poliammide nero - <i>Black polyamide</i>



TAPPO PROFILO TONDO - CAP ROUND PROFILE 45 x 45

CODICE CODE	MATERIALE MATERIAL
084.201.017	Poliammide nero - <i>Black polyamide</i>



TAPPO PROFILO - CAP PROFILE 45 x 60

CODICE CODE	MATERIALE MATERIAL
084.201.018	Poliammide nero - <i>Black polyamide</i>



TAPPO PROFILO - CAP PROFILE 45 x 90

CODICE CODE	MATERIALE MATERIAL
084.201.019	Poliammide nero - <i>Black polyamide</i>



TAPPO PROFILO - CAP PROFILE 45 x 135

CODICE CODE	MATERIALE MATERIAL
084.201.020	Poliammide nero - <i>Black polyamide</i>

A richiesta sono fornibili di colore grigio - *On request they are supplied in grey color*

084.201.003

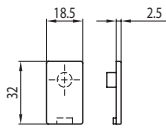

084.201.004

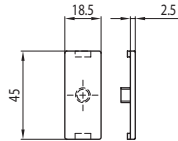

084.201.006

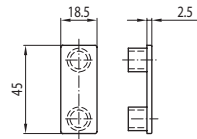

084.201.009

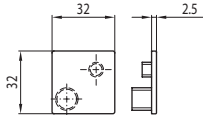

084.201.010

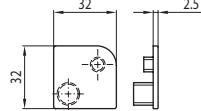

084.201.011

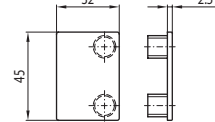

084.201.029

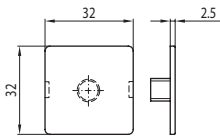

084.201.012

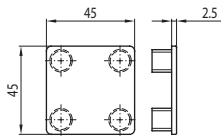

084.201.013

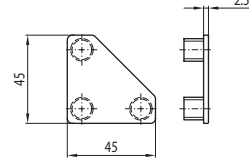

084.201.014

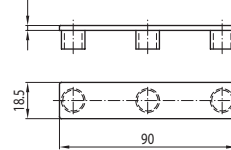

084.201.015

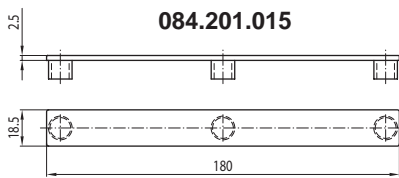

084.201.016

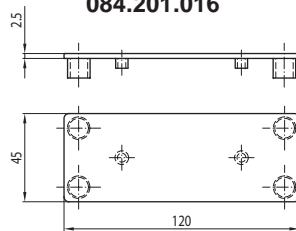

084.201.017

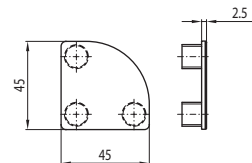

084.201.018

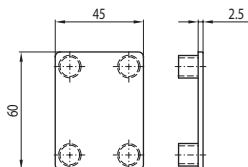

084.201.019

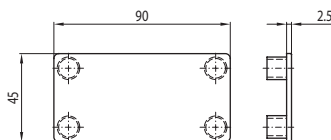

084.201.020

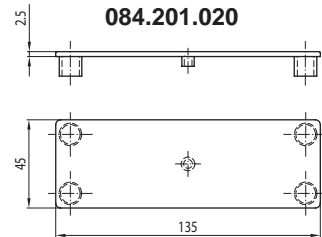

084.201.022

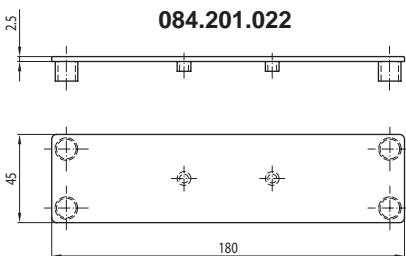

084.201.023

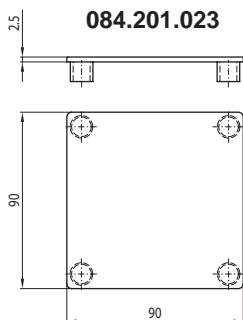

084.201.024

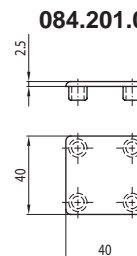

084.201.025

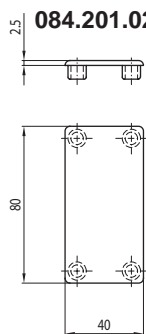

084.201.026

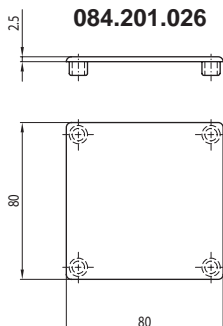

084.201.027

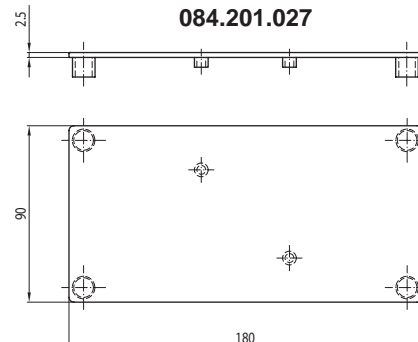



TAPPO PROFILO - CAP PROFILE 45 x 180

CODICE CODE	MATERIALE MATERIAL
084.201.022	Poliammide nero - <i>Black polyamide</i>



TAPPO PROFILO - CAP PROFILE 90 x 90

CODICE CODE	MATERIALE MATERIAL
084.201.023	Poliammide nero - <i>Black polyamide</i>



TAPPO PROFILO - CAP PROFILE 40 x 40

CODICE CODE	MATERIALE MATERIAL
084.201.024	Poliammide nero - <i>Black polyamide</i>



TAPPO PROFILO - CAP PROFILE 40 x 80

CODICE CODE	MATERIALE MATERIAL
084.201.025	Poliammide nero - <i>Black polyamide</i>

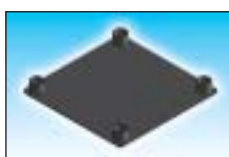

TAPPO PROFILO - CAP PROFILE 80 x 80

CODICE CODE	MATERIALE MATERIAL
084.201.026	Poliammide nero - <i>Black polyamide</i>



TAPPO PROFILO - CAP PROFILE 90 x 180

CODICE CODE	MATERIALE MATERIAL
084.201.027	Poliammide nero - <i>Black polyamide</i>

A richiesta sono fornibili di colore grigio - *On request they are supplied in grey color*

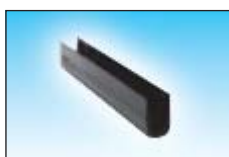

PROFILO CHIUSURA RIGIDO - RIGID GRIPPING PROFILE

CODICE CODE	DESCRIZIONE DESCRIPTION
084.203.002	PVC rigido nero - <i>Rigid black PVC</i>
084.203.003	PVC rigido grigio - <i>Rigid grey PVC</i> Lungh. standard 2000 mm <i>Standard length 2000 mm</i>

Per profili standard cava 8 - *Standard profiles quarry 8*

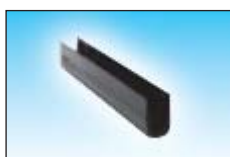

PROFILO CHIUSURA RIGIDO - RIGID GRIPPING PROFILE

CODICE CODE	DESCRIZIONE DESCRIPTION
084.203.007	PVC rigido grigio - <i>Rigid grey PVC</i> Lungh. standard 2000 mm <i>Standard length 2000 mm</i>

Per profili standard serie leggera cava 8
Light serie profiles quarry 8



PROFILO DISTANZIALE - DISTANCE PROFILE

CODICE CODE	DESCRIZIONE DESCRIPTION
084.204.001	PVC rigido grigio - <i>Rigid grey PVC</i> Lungh. standard 2000 mm <i>Standard length 2000 mm</i>



TAPPINI CHIUDI FORO - GRIPPING CAPS

CODICE CODE	DESCRIZIONE DESCRIPTION
084.202.002	Tappini in plastica grigio - <i>Plastic caps grey Ø 8</i>
084.202.005	Tappini in plastica grigio - <i>Plastic caps grey Ø 13</i>



PROFILO CHIUSURA CAVA - CHANNEL GRIPPING PROFILE

CODICE CODE	DESCRIZIONE DESCRIPTION
084.203.001	PVC morbido nero - <i>Soft black PVC</i> Rotolo da 50-100 m. - <i>Rolls 50-100 m.</i>
084.203.001G	PVC morbido grigio - <i>Soft grey PVC</i> Rotolo da 50-100 m. - <i>Rolls 50-100 m.</i>



PROFILO APPOGGIAPIEDI IN GOMMA
RUBBER PROFILE FOOT STOOL

CODICE CODE	DESCRIZIONE DESCRIPTION
084.205.001	PVC morbido nero - <i>Soft black PVC</i> Rotolo da 20 m. - <i>Rolls 20 m.</i>

Per profili 18 x 32, 32 x 32, 45 x 45
For profiles 18 x 32, 32 x 32, 45 x 45

084.203.001

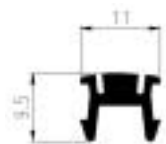

Guarnizione di chiusura per i profili con cava da 8 mm
Gripping packing for profiles with 8 mm quarry

084.204.001

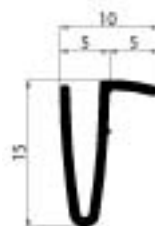

Profilo distanziale per il fissaggio di pannelli in rete
Distance profile for fixing panel elements

084.203.002-003



084.203.007

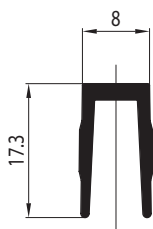

084.205.001

